

R10 series

General Purpose Dry Circuit to 7.5 Amp Multicontact AC or DC Relay

- R10-E – Clear Dust Cover Version
- R10-R – Sealed, Immersion Cleanable Type
- R10S – Super Sensitive, Logic Compatible

File E29244

File LR15734

Users should thoroughly review the technical data before selecting a product part number. It is recommended that user also seek out the pertinent approvals files of the agencies/laboratories and review them to ensure the product meets the requirements for a given application.

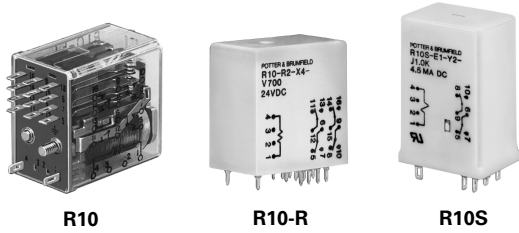

Features

- Broad range of coil options provide sensitivity ranging from 25 to 750mW.
- Various contacts switch from dry circuit to 7.5 amps.
- Many mounting and termination options.

Contact Data @ 25°C

Arrangements: 1 Form C (SPDT) through 8 Form C (8PDT) See Ordering Information tables for more details regarding availability.

Contact Materials, Styles & Ratings @ +25°C

Contact Code	Contact Material	Contact Style	Coil Codes Available	Contact Ratings		
				Min.	Typ.	Max.
W	Silver-Cadmium Oxide	Single Button	V, Q, S, J	500mA	-	7.5A‡
X	Silver-Cadmium Oxide	Single Button	V, Q, S, J	500mA	-	5A§
Y	Fine Silver	Single Button	All	100mA	2A	3A
Z	Fine Silver	Bifurcated	All	1mA	100mA	2A
P	Gold overlay on Silver	Bifurcated Crossbar	All	Dry Circuit	1mA	3A

Ratings are at 28VDC or 155VAC unless otherwise specified. Total load must not exceed 30A per relay.

‡ Use ungrounded frame for AC loads of 5A or greater. Max.ratings are 7.5A at 115VAC and 4A at 28VDC for coil codes S and J.

§ Use ungrounded frame for AC loads of 5A or greater. Max.ratings are 5A at 115VAC and 3A at 28VDC for coil codes S and J.

UL Horsepower Contact Ratings (Coil Code V Only)

Contact Code	No. of Poles	At 110-120VAC	At 220-240VAC
W	1, 2, 4	1/8 HP (3.8A)	1/6 HP (2.2A)
X	1, 2, 4, 6	1/20 HP (1.5A)	1/10 HP (1.5A)

Expected Mechanical Life: 100 million operations, typical. (Except contact Code W: 1,000,000 operations, typical.)

Typical Expected Life For Resistive Loads @ 25°C

Type	Current	Voltage	Contact Style	Coil Code	Operations††
R10	7.5A	120VAC, 60 Hz.	W	V,S,J	7.5 · 10 ⁴
R10	7.5A	28VDC	W	V	7.5 · 10 ⁴
R10	5.0A	120VAC, 60 Hz.	X	V,S,J	5 · 10 ⁴
R10	5.0A	28VDC	X	V	5 · 10 ⁴
R10	4.0A	28VDC	W	S,J	2 · 10 ⁴
R10	3.0A	28VDC	X	S,J	2 · 10 ⁴
R10	3.0A	28VDC or 120VAC	P	V,S,J	3 · 10 ⁴
R10	2.0A	28VDC	P,Y,Z	V	1.5 · 10 ⁶
R10	2.0A	28VDC	P,Y,Z	S,J	6 · 10 ⁵
R10S	2.0A	28VDC	P,Y,Z	J	5 · 10 ⁵
R10	1.0A	28VDC	P,Y,Z	V,S,J	12 · 10 ⁶
R10	1.0A	28VDC	P,Y,Z	SS,JJ	5 · 10 ⁵
R10S	1.0A	28VDC	P,Y,Z	J	1 · 10 ⁶
R10	500mA	28VDC	P,Y,Z	SS,JJ	5 · 10 ⁶
R10	100mA	28VDC or 120VAC	P,Y,Z	V,S,J	1 · 10 ⁸
R10	100mA	48VDC	P,Z	SS,JJ	5 · 10 ⁶
R10	100mA	6VDC	P	SS,JJ	5 · 10 ⁷
R10S	100mA	28VDC or 120VAC	P,Y,Z	J	1 · 10 ⁶
R10	50mA	6VDC	P,Z	V,S,J	5 · 10 ⁷
R10S	30mA	6VDC	P,Z	J	5 · 10 ⁶
R10	1mA	6VDC	P	SS,JJ	5 · 10 ⁷

†† Relay operated at rated coil voltage or 133% of pick-up current or higher.

Initial Dielectric Strength

Between Open Contacts: 500V rms, for contact codes P and Z. 1,000V rms for contact codes W, X and Y with coil code V.

Between All Other Conductors: 1,000V rms.

Dimensions are shown for reference purposes only.

Dimensions are in inches over (millimeters) unless otherwise specified.

Specifications and availability subject to change.

www.tycoelectronics.com
Technical support:
Refer to inside back cover.

Capacitance

Between Contacts: 2 pf, typ.

Between Contacts and Coil: 2 pf, typ.

Between Coil and Frame: 30 pf, typ.

Initial Insulation Resistance

Between Mutually Insulated Elements: 10¹⁰ ohms @ 25°C, 50% RH. Consult factory for optional acetal resin material rated 10¹² ohms.

Coil Data @ 25°C (also see Coil Data tables)

Voltage: 3 to 115VDC and 6 to 115VAC.

Maximum Coil Power: 2.2 Watts.

Coil Temperature Rise: 30°C per Watt.

Maximum Coil Temperature: 105°C.

Operate Data @ 25°C

R10 Relays (DC Only) Typical Ranges of Operations
(Curves for reference only. If specific values are required, testing is required.)

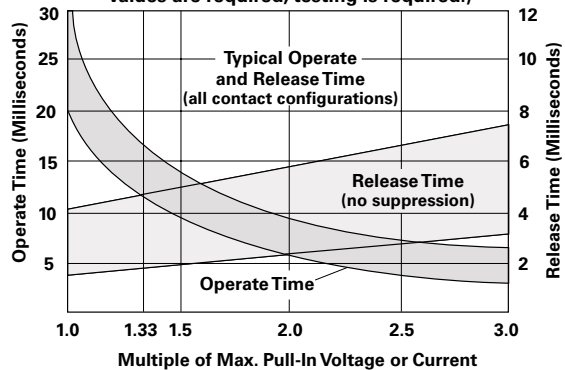

R10 Ultra-Sensitive "SS" and "JJ" Typical Ranges of Operation

(Curves for reference only. If specific values are required, testing is required.)

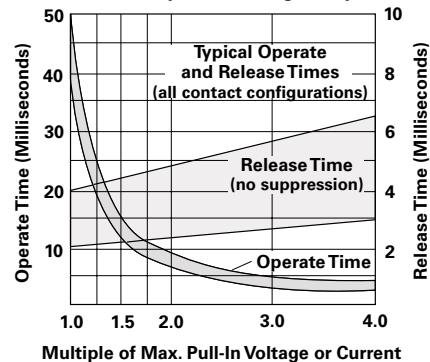

Environmental Data

Storage Temperature Range: -55°C to +105°C.

Operating Temperature Range: -55°C to +75°C.

Mechanical Data

Terminal Finish: Tin plating standard.

Weight: 0.8 to 1.4 oz. (23 to 40g) approximately.

Coil Data Tables @ 25°C

One of the **boldface** resistance or voltage values from a table below is to be inserted in step 6 of the ordering chart on the next page.

V Standard DC Voltage Adjustment					
2.2 Watts Maximum Continuous Coil Dissipation @ 25°C					
VDC at 25°C		Coil Resistance at 25°C ± 10% (ohms)			
Nominal	Pick-up (Max.)	1, 2 & 4 Form A, B, C or D Pick-up 500mW	6 Form A, B or C Pick-up 850mW	8 Form A, B or C Pick-up 1000mW	
3.0	2.25	10	6	5	
5.0	3.75	28	16	14	
6.0	4.5	52	25	20	
12.0	9.0	185	90	72	
24.0	18.0	700	430	350	
48.0	36.0	2.5K	1.5K	1.25K	
72.0	54.0	5.8K	3.5K	2.8K	
115.0	86.0	15.0K	9.0K	8.0K	

Q Special DC Voltage Adjustment						
1 & 2 Form A, B, C or D			3 & 4 Form A, B, C or D			Nominal Voltage @ 25°C (VDC)
Coil Res. @ 25°C ± 10% (ohms)	Pick-up (Max.) @ 25°C (VDC)	Pick-up @ 25°C (mW)	Coil Res. @ 25°C ± 10% (ohms)	Pick-Up (Max.) @ 25°C (VDC)	Pick-up @ 25°C (mW)	
52	3.1	180	32	3.8	450	5
110	4.5	185	52	4.2	340	6
450	9.2	190	185	8.4	380	12
1.8K	17.4	170	1.0K	17.2	295	24
7.5K	36.2	175	3.2K	31.1	300	48
15.0K	49.5	165	7.5K	49.3	325	72
30.0K	67.5	160	15.0K	67.5	300	115

S Sensitive DC Voltage Adjustment					
2.2 Watts Maximum Continuous Coil Dissipation @ 25°C					
VDC at 25°C		Coil Resistance at 25°C ± 10% (ohms)			
Nominal	Pick-up (Max.)	1 & 2 Form A, B, C or D Pick-up 100mW	3 & 4 Form A, B, C or D Pick-up 175mW	6 Form A, B or C Pick-up 250mW	8 Form A, B or C Pick-up 400mW
3.0	2.25	50	30	20	
5.0	3.75	140	80	56	
6.0	4.5	200	110	80	
12.0	9.0	800	450	320	
24.0	18.0	3.2K	1.8K	1.2K	
48.0	36.0	13.0K	7.5K	5.2K	
72.0	54.0	28.0K	16.0	13.0K	
115.0	86.0	50.0K	40.0K	30.0K	

SS Ultra-Sensitive Voltage Adjustment (1-4 Pole Only)				
2.2 Watts Maximum Continuous Coil Dissipation @ 25°C				
VDC at 25°C		Coil Resistance at 25°C ± 10% (ohms)		
Nominal	Pick-up (Max.)	1 Form C Pick-up Power 20mW	2 Form C Pick-up Power 40mW	3 & 4 Form C, Pick-up Power 80mW
3.0	2.25	220	110	52
5.0	3.75	700	350	175
6.0	4.5	1.0K	500	250
12.0	9.0	4.0K	2.0K	1.0K
18.0	13.5	9.0K	4.5K	2.2K
24.0	18.0	15.0K	7.5K	3.7K
36.0	27.0	30.0K	15.0K	7.5K
48.0	36.0	—	30.0K	15.0K

J Sensitive DC Current Adjustment					
Must Operate Current (mA)					
All Applicable Types Except R10S					
Coil Resistance ±10% (ohms)	2 Form A, B, C or D Pick-up 85mW	4 Form A, B, C or D Pick-up 175mW	6 Form A, B, C or D Pick-up 250mW	8 Form A, B or C Pick-up 400mW	Max. Coil Current (mA)
1.0K	8.5	13.0	16.0	20.0	45.0
2.5K	5.8	8.4	10.0	13.0	28.0
5.0K	4.1	6.2	7.2	9.0	20.0
10.0K	3.1	4.5	5.0	6.4	14.0
15.0K	2.6	3.5	4.2	5.3	11.5
30.0K	1.7	2.5	2.9	3.7	8.3

R10S Types Only			
Coil Resistance ±10% (ohms)	1 Form C Pick-up 10mW	2 Form C Pick-up 20mW	4 Form C Pick-up 40mW
500	4.5 (A)	6.3 (A)	9.0
1.0K	3.2 (A)	4.5	6.5
2.5K	2.0	2.9 (B)	4.1 (B)
5.0K	1.4 (B)	2.0	2.9 (C)
10.0K	1.0	1.4 (C)	2.0
16.0K	0.8	1.2	1.4
30.0K	0.6 (C)	0.8	1.2

(A) Suggested for 5VDC operation.
(B) Suggested for 12VDC operation.
(C) Suggested for 24VDC operation.

JJ Ultra-Sensitive Current Adjustment (1-4 Pole Only)				
Maximum Pick-Up Current (mA)				
Coil Resistance at 25°C ±10%	1 Form C Pick-Up Power 20mW	2 Form C Pick-Up Power 40mW	3 & 4 Form C Pick-Up Power 80mW	Maximum Continuous Coil Current (mA)
1.0K	4.5	6.5	9.0	45.0
2.5K	2.9	4.1	5.8	28.0
5.0K	2.1	2.9	4.1	20.0
10.0K	1.5	2.0	3.0	14.0
15.0K	1.2	1.7	2.4	11.5
30.0K	0.85	1.2	1.7	8.3

Standard AC Operated Relays				
Coil Resistance @ 25°C ± 20% (ohms)		Volts AC @ 25°C		
2 & 4 Form C	6 & 8 Form C	Pick-Up (max.)	Nominal	Maximum Continuous
25	15	5.0	6	7.2
120	90	9.0	12	14.5
500	350	18.0	24	30.0
2.0K	1.4K	36.0	48	60.0
9.0K	7.5K	86.0	115	130.0

Note: Dual coil diode rectified construction.

Typical Coil Inductance

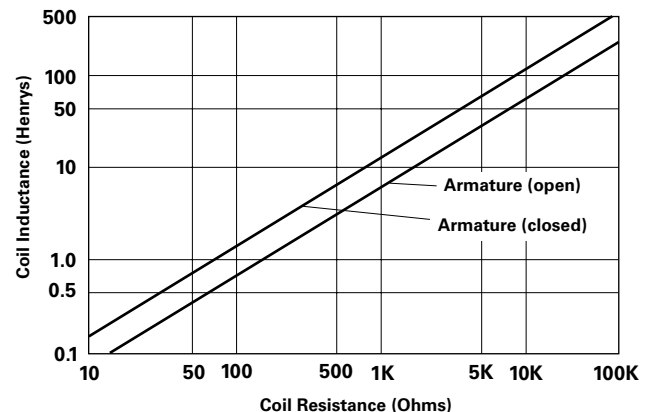

Ordering Information

Typical Part Number ▶

R10

-E

1

Y

4

-V700

1. Basic Series:

R10 = Relay with Form C contacts.

R10S = Super sensitive R10 (case and terminals E1 & E2 only, J coil adj. only).

2. Case Style:

E = Non-sealed polycarbonate cover.

R = Immersion cleanable, tape sealed plastic case (R10 only [Form C], terminal code 2 & 9 only [std. PCB]).

No ground or stud included. Not available on R10S.

3. Terminals & Mounting:

1 = Solder/plug-in terminals with #3-48 mounting stud.

2 = Printed circuit terminals (std.) .064" (1.62mm) clearance, 1.25" (31.75mm) seated ht.

6 = Side mounting plate with #6-32 stud, solder/plug-in terminals (#3-48 stud not included).

7 = Narrow (.04" [1.02mm] wide) printed circuit terminals .013" (.33mm) clearance, 1.2" (30.48mm) seated ht.

9 = Non-shouldered, narrow (.04" [1.02mm] wide) printed circuit terminals in a staggered arrangement (1 to 6 poles only).

4. Contact Style & Rating:

	W	X	Y	Z	P
	Single Contact	Single Contact	Single Contact	Bifurcated, Low Level Contacts	Bifurcated Crossbar, Dry Circuit Contacts
	V, Q, S & J Coil Adjustment Only				
	Max. 7.5A† Min. 500mA	Max. 5A‡ Min. 500mA	Typ. 2A Max. 3A Min. 100mA	Typ. 100mA Max. 2A Min. 1mA	Typ. 1mA Max. 3A Min. Dry Circuit
R10	X	X	X	X	X
R10S			X	X	X

Ratings are at 28VDC or 115VAC. Total load must not exceed 30A per relay.

† Use ungrounded frame for AC loads of 5A or greater. Max. ratings are 7.5A at 115VAC and 4A at 28VDC for coil codes S & J.

‡ Use ungrounded frame for AC loads of 5A or greater. Max. ratings are 5A at 115VAC and 3A at 28VDC for coil codes S & J.

5. Number of Poles:

1 = 1 pole.

4 = 4 pole

2 = 2 pole.

6 = 6 pole (not available with W contacts).

3 = 3 pole.

8 = 8 pole (available on case style E only; not available with W contacts).

6. Coil (Refer to Coil Data Tables):

AC Voltage (available on R10 only)

Specify nominal coil voltage followed by V (example: 24V).

DC Voltage

Specify coil adjustment code letter followed by coil resistance (example: V700).

Our authorized distributors are more likely to stock the following items for immediate delivery.

R10-E1P2-115V	R10-E1X2-24V	R10-E1Y2-J1.0K	R10-E1Y4-V700	R10-E2P4-V185	R10-E2Y4-V185
R10-E1P2-V700	R10-E1X2-S800	R10-E1Y2-J2.5K	R10-E1Y6-V1.5K	R10-E2P4-V700	R10-E2Y4-V700
R10-E1P4-115V	R10-E1X2-V185	R10-E1Y2-V15.0K	R10-E1Z2-V185	R10-E2W2-V185	R10S-E1Y2-J5.0K
R10-E1P4-V700	R10-E1X2-V700	R10-E1Y2-V185	R10-E1Z2-V700	R10-E2X2-V185	R10S-E2Y1-J1.0K
R10-E1W2-V185	R10-E1X4-115V	R10-E1Y2-V2.5K	R10-E1Z4-V185	R10-E2X2-V700	
R10-E1W2-V700	R10-E1X4-V185	R10-E1Y2-V700	R10-E1Z4-V2.5K	R10-E2X4-V185	
R10-E1W4-V185	R10-E1X4-V2.5K	R10-E1Y4-J10.0K	R10-E1Z4-V700	R10-E2X4-V700	
R10-E1W4-V700	R10-E1X4-V700	R10-E1Y4-V2.5K	R10-E1Z6-V1.5K	R10-E2Y2-V185	
R10-E1X2-115V	R10-E1X6-V430	R10-E1Y4-V52	R10-E1Z6-V430	R10-E2Y2-V700	

Outline Dimensions

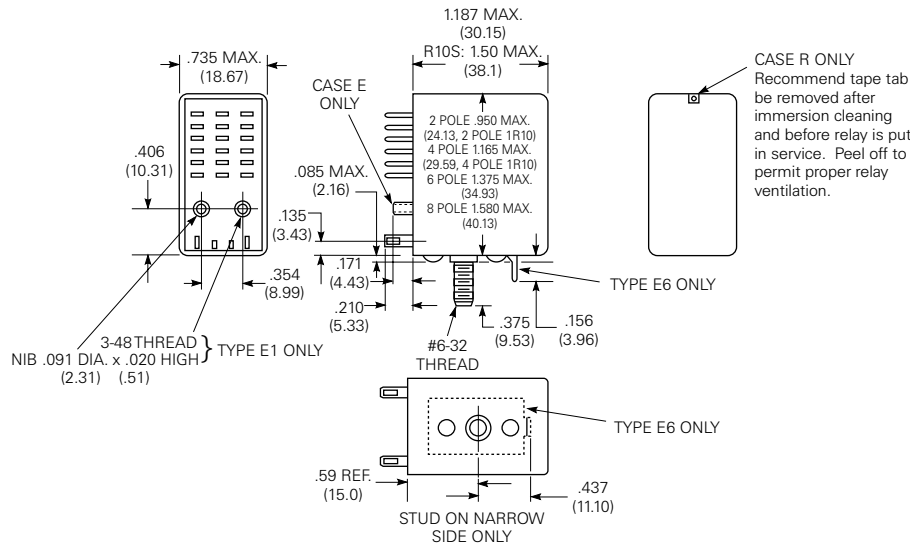

CASE R ONLY
Recommend tape tab be removed after immersion cleaning and before relay is put in service. Peel off to permit proper relay ventilation.

Solder Terminal Dimensions

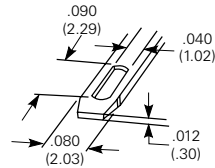

PC Terminal Dimensions

	A	B	C	D	Arrang.
Type 2	.131	.050	.064	1.251	Inline
Type 7	.131	.040	.013	1.20	Inline
Type 9	.170	.040	.000	1.187	Staggered
Thickness	.012	.012	.012	.013	—

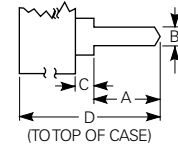

Wiring Diagrams (Bottom Views)

R10 Wiring Diagrams

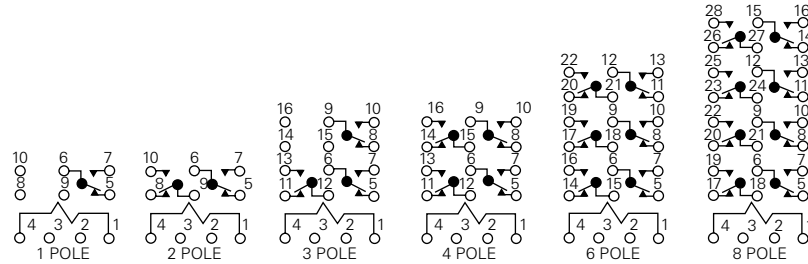

R10-AC Wiring Diagram

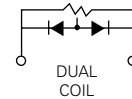

Suggested PC Board Layouts (Component Side of Boards)

Terminal Types E2 & R2

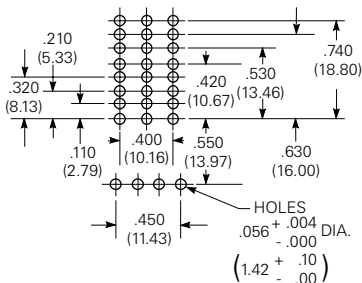

Terminal Types E9 & R9

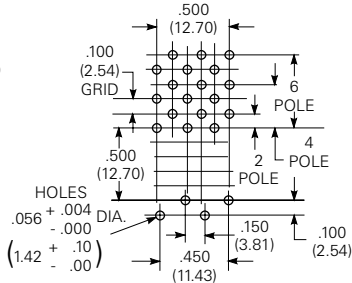

Suggested Panel Cutout For Relay or Socket

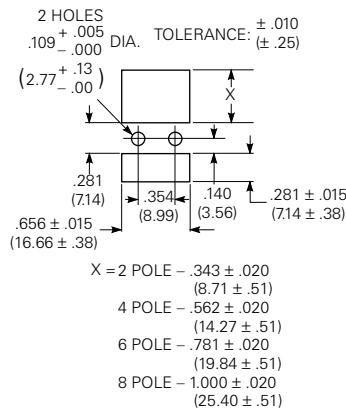

Mounting Hole Layout For Terminal & Mounting Style 6

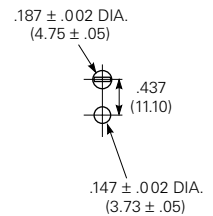

R10 Socket & Accessory Information



Socket Specifications

Contact Material:

Spring brass, tin-plated.

Body Material: 2 and 4 pole: polyester.
6 and 8 pole: phenolic.

Voltage Drop: 30mV max. @ 10A.

Dielectric Strength: 1,000V rms.

Insulation Resistance: 10⁹ megohms.

Max. Current: 10A.

Solder or PC Terminal Sockets

Rugged, molded socket body retains floating terminals of either solder or printed circuit pin configuration. PC terminal sockets are offered with pins in either 0.1" (2.54mm) grid or in-line arrangement.

Grounding Provisions

Pre-installed on sockets

Not for use at 5A AC and above.

Grounding Strip: Mounting stud of relay contacts grounding strip. Grounding strip is grounded with screw or rivet through round hole in socket.

Grounding Terminal (PC sockets only):

Mounting stud of relay contacts ground terminal through square hole in socket.

Strip

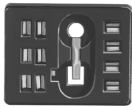

Terminal



Caution:

Printed circuit sockets are manufactured with "floating" (loose) terminals. This permits them to align with holes in the circuit board and with the relay terminals. During the mounting and soldering of the socket, vertical float should be eliminated and the terminals seated on the board. (This may be accomplished by inserting a dummy relay in the socket.) Failure to eliminate float may cause fracture of the solder joint or separation of the copper conductor from the printed circuit board when a relay is inserted in the socket after soldering.

Ordering Data – Stock items are boldfaced.

Socket Part No.	No. of Poles	Type of Terminal	Grounding Provision
27E125	2	Solder	Strip
27E126	4		Strip
27E127	6		Strip
27E162	2		None
27E163	4		None
27E164	6		None
27E128	2	PC Stag. .180" long (4.57mm)	Strip
27E129	4		Strip
27E130	6		Strip
27E254	8		Strip
27E212	2		None
27E213	4		None
27E271	6		None
27E258	8		None
27E193	2		Terminal
27E194	4		Terminal
27E636	2	PC Stag. .210" long (5.33mm)	Strip
27E637	4	Strip	Strip
27E631	2	PC In-line .180" long (4.57mm)	Strip
27E632	4		Strip
27E340	6		Strip
27E342	2		None
27E629	4		None
27E630	6		None
27E338	4		Terminal
27E633	2		PC In-line .210" long (5.33mm)
27E634	4	Strip	Strip
27E635	6	Strip	Strip

All tolerances ±.010 (±.25) unless otherwise noted.

Suggested Panel Cutout

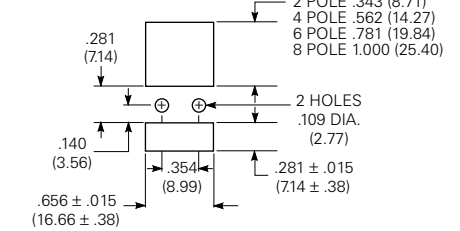

Suggested Board Layout (Component Side)

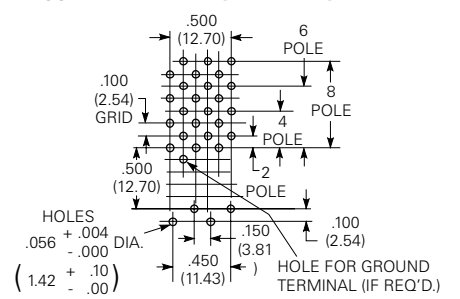

Suggested Board Layout (Component Side)

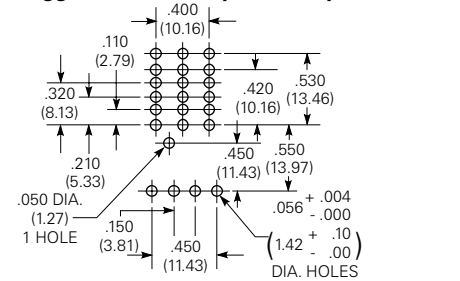

Hold Downs For Use With R10 Sockets

Part No.	No. of Poles	Description
20C249	2	Wire Hold Down Spring
20C250	4	Wire Hold Down Spring
20C251	6	Wire Hold Down Spring
20C266	8	Wire Hold Down Spring
20C259	All	Wire Hold Down Strap (PC only)
20C300	2 (R10S)	Hold Down Spring
20C301	4 (R10S)	Hold Down Spring

Hold Down Spring



Hold Down Strap (PC Sockets Only)



See following page for additional sockets & accessories.

Solder & PC Terminal Socket Outline Dimensions

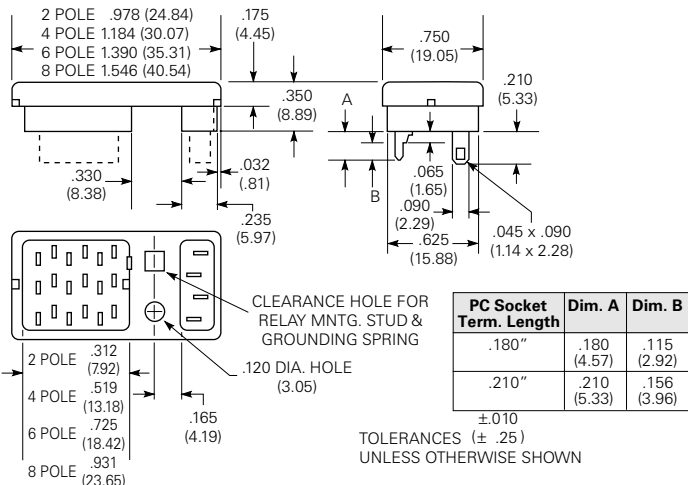

37D645 – Mounting Strip

Strip of .060" (1.52mm) aluminum contains ten pre-punched, breakaway mounting plates. Each plate accommodates a 2, 4, 6 or 8 pole solder terminal R10 relay or socket to facilitate chassis- or rack mounting.

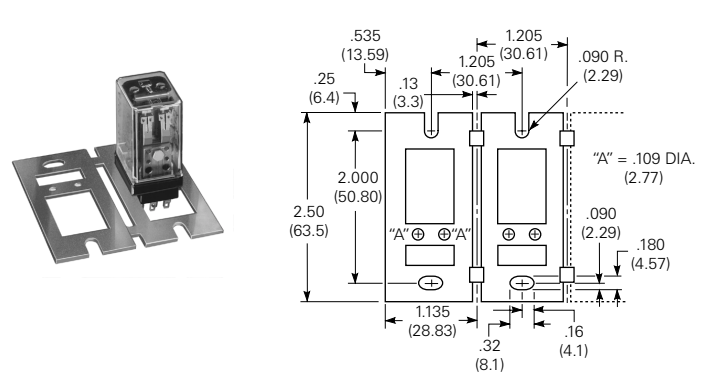

R10 Socket & Accessory Information (Continued)

Ordering Data – Stock items are boldfaced.

Socket Part No.	No. of Poles	Type of Terminal	Grounding Provision
27E317	2	Solder/Bracket	Strip
27E152	4	Solder/Bracket	Strip

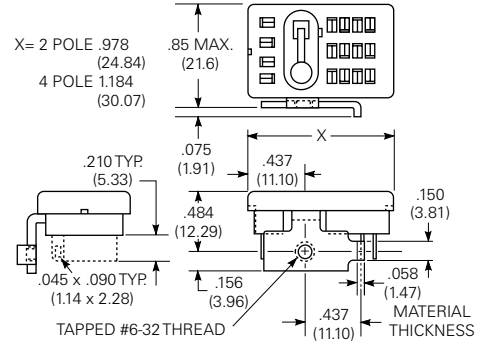

Bracket Mount Socket
Allows solder terminal relay to mount flat on a chassis.



Flange Mount Socket
Solder terminal socket with tin-plated terminals and grounding strip pre-assembled on .065" (1.65mm) steel mounting plate. Requires only one chassis cutout.

Socket Part No.	No. of Poles	Dim. A Nom.	Dim. B Max.	Dim. C Min.
27E446	2	1.437 (36.50)	1.822 (46.27)	.937 (23.80)
27E447	4	1.687 (42.85)	2.072 (52.63)	1.125 (28.58)
27E448	6	1.875 (47.63)	2.260 (57.40)	1.343 (34.11)

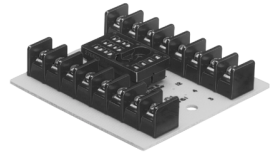
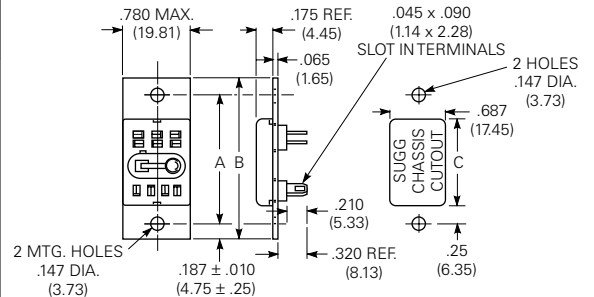

Track Mount Socket
Provides front wiring, screw terminal connections for R10 family relays. No grounding provision.

Part No.	No. of Poles	Dim. A Nom.	Dim. B Max.	Dim. C Nom.
27E460	2	1.800 (45.72)	2.230 (56.64)	.200 (5.08)
27E461	4	2.125 (53.98)	2.830 (71.88)	.337 (8.56)
27E462	6	2.812 (71.42)	3.830 (97.28)	.494 (12.55)

2 Pole Terminal Wiring Code

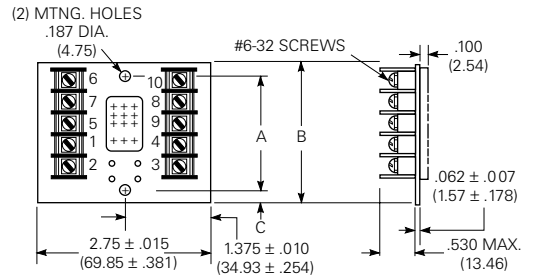

See preceding page for hold down springs.

4 Pole Terminal Wiring Code

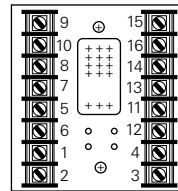

6 Pole Terminal Wiring Code

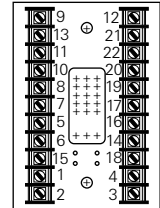

Suggested Track Mounting

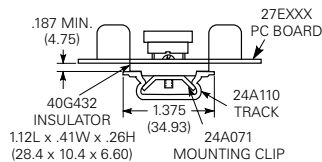

Suggested Chassis Mounting

